



## **AM-270**

**Industrial Multimeter with  
Bar-graph Display**

### **Users Manual**

- Mode d'emploi
- Bedienungshandbuch
- Manual d'Uso
- Manual de uso





# AM-270

## Industrial Multimeter with Bar-graph Display

Users Manual

May 2010, Rev.1  
©2010 Amprobe Test Tools.  
All rights reserved. Printed in Taiwan

English

## Limited Warranty and Limitation of Liability

Your Amprobe product will be free from defects in material and workmanship for 1 year from the date of purchase. This warranty does not cover fuses, disposable batteries or damage from accident, neglect, misuse, alteration, contamination, or abnormal conditions of operation or handling. Resellers are not authorized to extend any other warranty on Amprobe's behalf. To obtain service during the warranty period, return the product with proof of purchase to an authorized Amprobe Test Tools Service Center or to an Amprobe dealer or distributor. See Repair Section for details. **THIS WARRANTY IS YOUR ONLY REMEDY. ALL OTHER WARRANTIES - WHETHER EXPRESS, IMPLIED OR STATUTORY - INCLUDING IMPLIED WARRANTIES OF FITNESS FOR A PARTICULAR PURPOSE OR MERCHANTABILITY, ARE HEREBY DISCLAIMED. MANUFACTURER SHALL NOT BE LIABLE FOR ANY SPECIAL, INDIRECT, INCIDENTAL OR CONSEQUENTIAL DAMAGES OR LOSSES, ARISING FROM ANY CAUSE OR THEORY.** Since some states or countries do not allow the exclusion or limitation of an implied warranty or of incidental or consequential damages, this limitation of liability may not apply to you.

### Repair

All test tools returned for warranty or non-warranty repair or for calibration should be accompanied by the following: your name, company's name, address, telephone number, and proof of purchase. Additionally, please include a brief description of the problem or the service requested and include the test leads with the meter. Non-warranty repair or replacement charges should be remitted in the form of a check, a money order, credit card with expiration date, or a purchase order made payable to Amprobe® Test Tools.

### In-Warranty Repairs and Replacement – All Countries

Please read the warranty statement and check your battery before requesting repair. During the warranty period any defective test tool can be returned to your Amprobe® Test Tools distributor for an exchange for the same or like product. Please check the "Where to Buy" section on [www.amprobe.com](http://www.amprobe.com) for a list of distributors near you. Additionally, in the United States and Canada In-Warranty repair and replacement units can also be sent to a Amprobe® Test Tools Service Center (see next page for address).

### Non-Warranty Repairs and Replacement – US and Canada

Non-warranty repairs in the United States and Canada should be sent to a Amprobe® Test Tools Service Center. Call Amprobe® Test Tools or inquire at your point of purchase for current repair and replacement rates.

#### In USA            In Canada

Amprobe Test Tools	Amprobe Test Tools
Everett, WA 98203	Mississauga, ON L4Z 1X9
Tel: 888-993-5853	Tel: 905-890-7600
Fax: 425-446-6390	Fax: 905-890-6866

### Non-Warranty Repairs and Replacement – Europe

European non-warranty units can be replaced by your Amprobe® Test Tools distributor for a nominal charge. Please check the "Where to Buy" section on [www.amprobe.com](http://www.amprobe.com) for a list of distributors near you.

Amprobe® Test Tools Europe  
In den Engematten 14  
79286 Glottertal, Germany  
tel: +49 (0) 7684 8009 - 0

\*(Correspondence only – no repair or replacement available from this address. European customers please contact your distributor.)



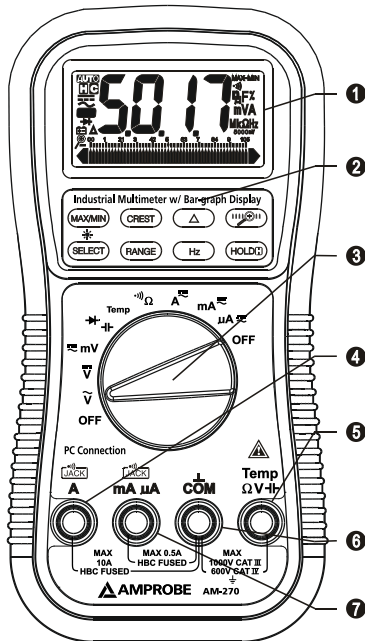

## AM-270 Industrial Multimeter with Bar-graph Display













- 1 3-4/5 digits 5000 counts LCD display
- 2 Push-buttons for special functions & features
- 3 Selector to turn the Power On or Off and select a function
- 4 Input Jack for 10A (20A for 30sec) current function
- 5 Input Jack for all functions EXCEPT current ( $\mu$ A, mA, A) functions
- 6 Common (Ground reference) Input Jack for all functions
- 7 Input Jack for milli-amp and micro-amp current functions

# CONTENTS

---

<b>SYMBOLS</b> .....	1
<b>UNPACKING AND INSPECTION</b> .....	3
<b>FEATURES</b> .....	3
<b>OPERATION</b> .....	4
DC Voltage, AC Voltage, & Hz Frequency Functions.....	4
 Capacitance,  Diode Test Function .....	5
Temperature Function .....	6
$\Omega$ Resistance,  Continuity Functions.....	8
Auto Leads Resistance Calibration.....	8
$\mu$ A, mA, and A Current Functions .....	9
PC-COMM Computer Interface Capabilities .....	10
50ms MAX/MIN at Fast 20/s Measurement Mode .....	10
0.8ms CREST Capture Mode .....	10
Backlighted Display .....	11
Hold  .....	11
Zoom 5x Analog Pointer.....	11
 Relative Mode .....	12
Manual or Auto-Ranging .....	12
Beep-Jack™ Input Warning.....	13
Set Beeper Off.....	13
Auto Power Off (APO) .....	13
Disabling Auto Power Off .....	13
<b>SPECIFICATION</b> .....	13
<b>MAINTENANCE AND REPAIR</b> .....	19
Trouble Shooting.....	19
Cleaning and Storage .....	20
Battery and Fuse Replacement.....	20

## SYMBOLS

	Caution ! Risk of electric shock
	Caution ! Refer to the explanation in this Manual
	Double Insulation or Reinforced insulation
	Alternating Current (AC).
	Direct Current (DC).
	Fuse
	Earth (Ground)
	Please remove all the test leads before performing maintenance, cleaning, battery replacement, fuse replacement, etc
	Complies with European Directives
	Conforms to relevant Australian standards
	Do not dispose of this product as unsorted municipal waste. Contact a qualified recycler for disposal

## Safety Information

This manual contains information and warnings that must be followed for operating the instrument safely and maintaining the instrument in a safe operating condition. If the instrument is used in a manner not specified by the manufacturer, the protection provided by the instrument may be impaired. The meter is intended only for indoor use.

The meter protection rating, against the users, is double insulation per IEC61010-1 2nd Ed., EN61010-1 2nd Ed., UL61010-1 2nd Ed. and CAN/CSA C22.2 No. 61010.1-0.92 to Category III 1000 Volts AC & DC and Category IV 600 Volts AC & DC.

### Measurement category:

**V** : Category III 1000 Volts AC & DC, and Category IV 600 Volts AC & DC.

**A / mA $\mu$ A** : Category III and Category IV 600 Volts AC and 300 Volts DC.

Per IEC61010-1 2nd Ed. (2001) Measurement Category

**Measurement Category IV (CAT IV)** is for measurements performed at the source of the low-voltage installation. Examples are electricity meters and measurements on primary overcurrent protection devices and ripple control units.

**Measurement Category III (CAT III)** is for measurements performed in the building installation. Examples are measurements on distribution boards, circuit-breakers, wiring, including cables, bus-bars, junction boxes, switches, socket-outlets in the fixed installation, and equipment for industrial use and some other equipment, for example, stationary motors with permanent connection to the fixed installation.

**Measurement Category II (CAT II)** is for measurements performed on circuits directly connected to the low voltage installation. Examples are measurements on household appliances, portable tools and similar equipment.

#### **WARNING**

*To reduce the risk of fire or electric shock, do not expose this product to rain or moisture. To avoid electrical shock hazard, observe the proper safety precautions when working with voltages above 60 VDC or 30 VAC rms. These voltage levels pose a potential shock hazard to the user. Do not touch test lead tips or the circuit being tested while power is applied to the circuit being measured. Keep your fingers behind the finger guards of the test leads during measurement. Inspect test leads, connectors, and probes for damaged insulation or exposed metal before using the instrument. If any defects are found, replace them immediately. Do not measure any current that exceeds the current rating of the protection fuse. Do not attempt a current measurement to any circuit where the open circuit voltage is above the protection fuse voltage rating. Suspected open circuit voltage should be checked with voltage functions. Never attempt a voltage measurement with the test lead inserted into the  $\mu A/mA$  or A input jack. Only replace the blown fuse with the proper rating as specified in this manual. Only use the accompanied test leads, or replace with the same rating or better.*

#### **CAUTION**

*Disconnect the test leads from the test points before changing functions. Always set the instrument to the highest range and work downward for an unknown value when using manual ranging mode.*



## **CENELEC Directives**

The instruments conform to CENELEC Low-voltage directive 2006/95/EC and Electromagnetic compatibility directive 2004/108/EC

## **UNPACKING AND INSPECTION**

---

Your shipping carton should include:

- 1 AM-270 Meter
- 1 Test Leads (1 pair)
- 1 K Type thermal couple with banana plug
- 1 Users Manual
- 1 Single Alkaline 9V battery; NEDA1604A, JIS6AM6 OR IEC6LF22(Installed)

If any of the items are damaged or missing, return the complete package to the place of purchase for an exchange.

## **FEATURES**

---

### **Analog Bar-graph**

MS (Root-Mean-Square) is the term used to describe the effective or equivalent DC value of an AC signal. Most digital multimeters use average sensing RMS calibrated technique

### **Average Sensing RMS Calibrated**

RMS (Root-Mean-Square) is the term used to describe the effective or equivalent DC value of an AC signal. Most digital multimeters use average sensing RMS calibrated technique to measure RMS values of AC signals. This technique is to obtain the average value by rectifying and filtering the AC signal. The average value is then scaled upward (calibrated) to read the RMS value of a sine wave. In measuring pure sinusoidal waveform, this technique is fast, accurate, and cost effective. In measuring non-sinusoidal waveforms, however, significant errors can be introduced because of different scaling factors relating average to RMS values.

### **True RMS**

True RMS is a term which identifies a DMM that responds accurately to the effective RMS value regardless of the waveforms such as: square, saw tooth, triangle, pulse trains, spikes, as well as distorted waveforms with the presence of harmonics. Harmonics may cause :

- Overheated transformers, generators and motors to burn out faster than normal
- Circuit breakers to trip prematurely
- Fuses to blow
- Neutrals to overheat due to the triplen harmonics present on the neutral
- Bus bars and electrical panels to vibrate

## Crest Factor

Crest Factor is the ratio of the Crest (instantaneous peak) value to the True RMS value, and is commonly used to define the dynamic range of a True RMS DMM. A pure sinusoidal waveform has a Crest Factor of 1.4. A badly distorted sinusoidal waveform normally has a much higher Crest Factor.

## NMRR (Normal Mode Rejection Ratio)

NMRR is the DMM's ability to reject unwanted AC noise effect that can cause inaccurate DC measurements. NMRR is typically specified in terms of dB (decibel). This series has a NMRR specification of > 60dB at 50 and 60Hz, which is a good and definite ability to reject the effect of AC noise when making DC measurements.

## CMRR (Common Mode Rejection Ratio)

Common mode voltage is voltage present on both the COM and VOLTAGE input terminals of a DMM, with respect to ground. CMRR is the DMM's ability to reject common mode voltage effect that can cause digit rolling or offset in voltage measurements. This series has a CMRR specifications of > 80dB at DC to 60Hz in ACV function; and > 120dB at DC, 50 and 60Hz in DCV function. If neither NMRR nor CMRR specification is specified, a DMM's performance will be uncertain.

## OPERATION

---

### **⚠ CAUTION**

*Before and after hazardous voltage measurements, test the voltage function on a known source such as line voltage to determine proper meter functioning.*

## DC Voltage, AC Voltage, & Hz Frequency Functions

ImV function defaults at DC. Press SELECT button momentarily to select AC. Press the Hz push-button momentarily to activate or to exit Hz.

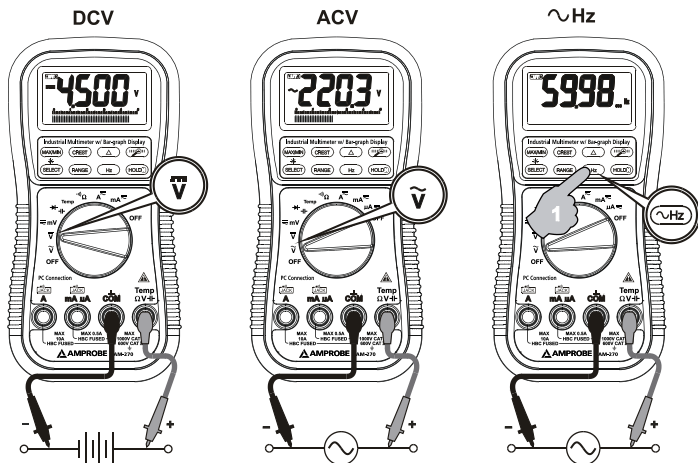

**Note:** Input sensitivity varies automatically with function range selected before activating the Hz function. mV function has the highest (300mV) and the 1000V range has the lowest (300V). It is recommended to first measure the signal voltage (or current) level then activate the Hz function in that voltage (or current) range to automatically set the most appropriate trigger level. You can also press the RANGE button momentarily to select another trigger level manually. If the Hz reading becomes unstable, select lower sensitivity to avoid electrical noise. If the reading shows zero, select higher sensitivity.

## ⚡ Capacitance, ⚡ Diode Test Function

Default at ⚡. Press SELECT button momentarily to select ⚡ Diode test function.

### ⚠ CAUTION

*Discharge capacitors before making any measurement. Large value capacitors should be discharged through an appropriate resistance load.*

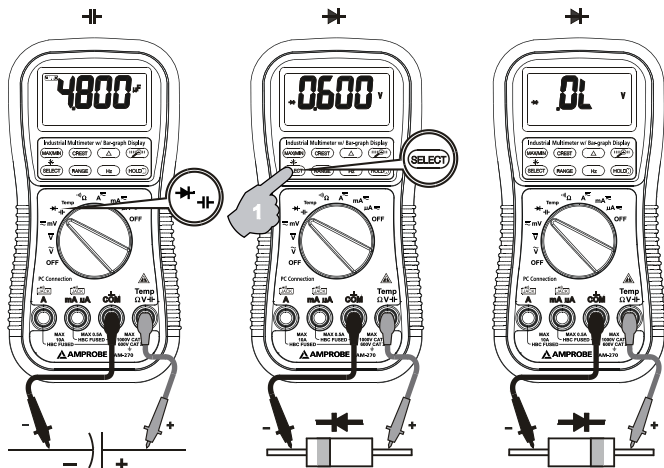

Normal forward voltage drop (forward biased) for a good silicon diode is between 0.400V to 0.900V. A reading higher than that indicates a leaky diode (defective). A zero reading indicates a shorted diode (defective). An OL indicates an open diode (defective). Reverse the test leads connections (reverse biased) across the diode. The digital display shows OL if the diode is good. Any other readings indicate the diode is resistive or shorted (defective).

## Temperature Function

Press SELECT button momentarily to toggle between °C and °F readings, and the new setting will be saved automatically in the non-volatile memory as power up default.

K-temp

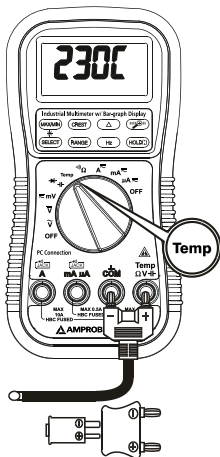

K-temp

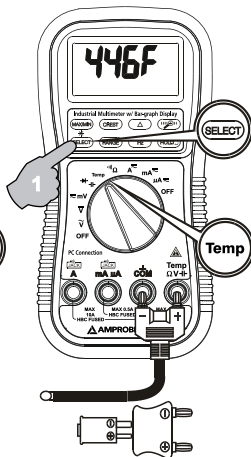

**Note:** Be sure to insert the banana plug K-type temperature bead probe Bkp60 with correct  $+$   $-$  polarities.

$\Omega$

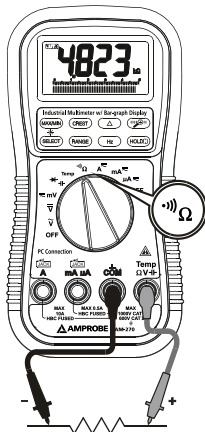

$\Omega$

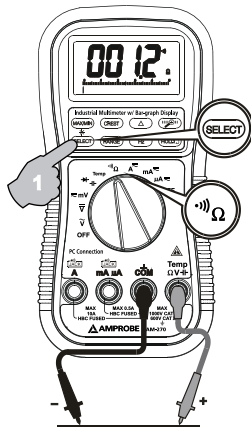

## $\Omega$ Resistance, $\cdot\Omega$ ) Continuity Functions $\pm$ —

Default at  $\Omega$ . Press SELECT button momentarily to select  $\cdot\Omega$ ) Continuity function that is convenient for checking wiring connections and operation of switches. A continuous beep tone indicates a complete wire.

### **CAUTION**

*Using resistance or continuity function in a live circuit will produce false results and may damage the meter. In many cases the suspected component must be disconnected from the circuit to obtain an accurate reading.*

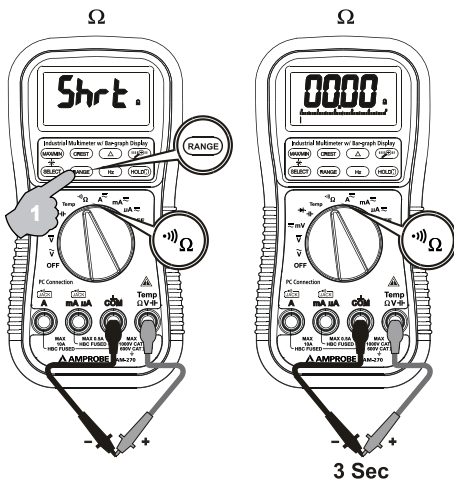

### **Auto Leads Resistance Calibration**

When entering the  $50\Omega$  range manually by RANGE button for high precision low resistance measurement, this feature will prompt you to short the inputs for calibration. The display shows "Shrt". Simply short the leads for about 3 seconds until the display shows zero, then the resistance in the leads and in the internal protection circuitry of the meter is compensated automatically. The compensation value can be as much as  $5\Omega$ . If you need a compensation value that is higher than that, Relative mode is recommended.

The shortcut is to short the test leads in auto-ranging resistance mode until the meter enters the lowest 50 $\Omega$  range automatically, press the RANGE button momentarily to get the "Shrt" prompt, then wait about 3 more seconds until the display shows zero.

**Note:** The calibration stays until you change ranges, functions, or go back to auto-ranging mode.

## $\mu\text{A}$ , mA, and A Current Functions

Default at DC. Press SELECT button momentarily to select AC.

**\*Note:** When measuring a 3-phase system, special attention should be taken to the phase-to-phase voltage which is significantly higher than the phase-to-earth voltage. To avoid exceeding the voltage rating of the protection fuse(s) accidentally, always consider the phase-to-phase voltage as the working voltage for the protection fuse(s).

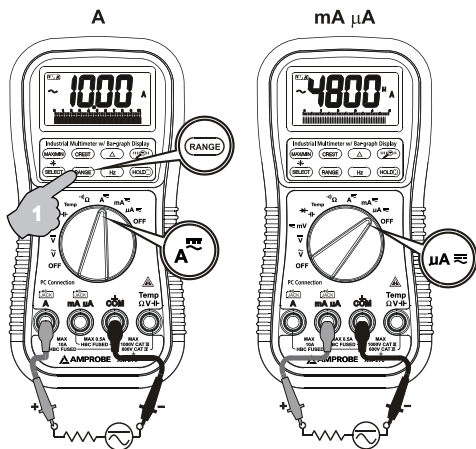

## PC-COMM Computer Interface Capabilities

The instrument equips with an optical isolated interface port at the meter back for data communication. Optional purchase PC interface kit USB-KIT3 is required to connect the meter to the PC computer. The USB-KIT3 Data Recording System software equips with a digital meter, an analog meter, a comparator meter, and a Data Graphical recorder display. Refer to the README file in the interface kit for further details.

## 50ms MAX/MIN at Fast 20/s Measurement Mode

Press MAX/MIN button momentarily to activate MAX/MIN recording mode. The LCD annunciators "MAX MIN" turn on, and the reading update rate will be increased to 20/second. The meter beeps when new maximum or minimum reading is updated. Press the button momentarily to read throughout the Maximum (MAX), Minimum (MIN), and Maximum minus Minimum (MAX-MIN) readings. Press the button for 1 second or more to exit MAX/MIN mode. Auto Power Off feature will be disabled automatically in this mode.

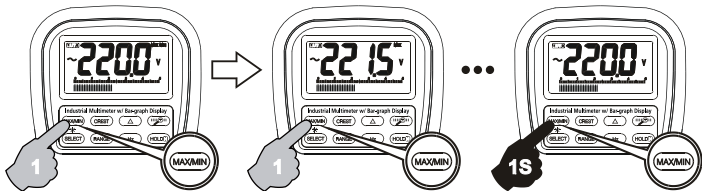

## 0.8ms CREST Capture Mode

Press CREST button momentarily to activate CREST (Instantaneous Peak-Hold) mode to capture voltage or current signal duration as short as 0.8ms. This mode is available in DCV, ACV, DCA, & ACA functions. The LCD annunciators "C" & "MAX" turn on. The meter beeps when new maximum or minimum reading is updated. Press the button momentarily to read throughout the Maximum (MAX), Minimum (MIN), and Maximum minus Minimum (MAX-MIN) readings. Press the button for 1 second or more to exit CREST capture mode. Auto Power Off feature will be disabled automatically in this mode.



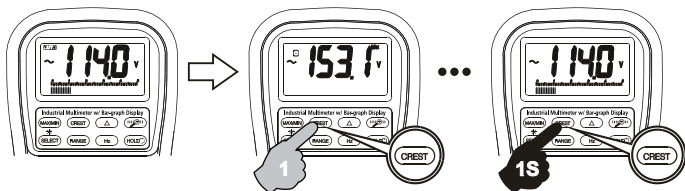

## Backlight Display

Press the SELECT button for 1 second or more to turn on or off the display backlight function. The backlight will also be turned off automatically after 30 seconds to extend battery life.



## Hold

The hold function freezes the display for later view. Press the HOLD button momentarily to activate or to exit the hold function

**HOLD **

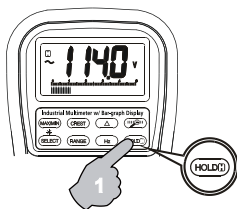

## Zoom 5x Analog Pointer

The Zoom mode analog pointer magnifies up to 5 times the regular analog bar graph resolution to show minute signal changes with a single analog pointer. It is virtually equivalent to the bar graph resolution of  $5 \times 50 = 250$  segments.

## ZOOM

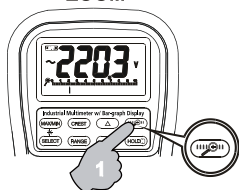

## △Relative Mode

Relative zero allows the user to offset the meter consecutive measurements with the displaying reading as the reference value. Practically all displaying readings can be set as relative reference value including MAX/MIN feature readings. Press the  $\Delta$  button momentarily to activate and to exit relative zero mode.

## REL

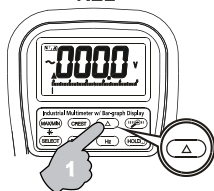

## Manual or Auto-Ranging

Press the RANGE button momentarily to select manual-ranging, and the meter will remain in the range it was in, the LCD annunciator **AUTO** turns off. Press the button momentarily again to step through the ranges. Press and hold the button for 1 second or more to resume auto-ranging.

**Note:** Manual ranging feature is not available in Hz function.

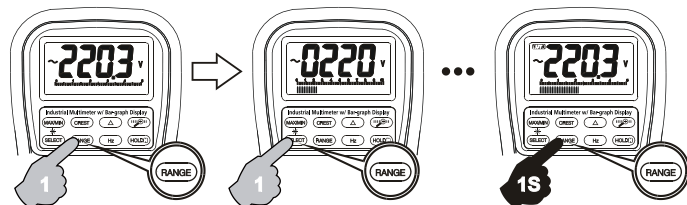

## Beep-Jack™ Input Warning

The meter beeps as well as displays "InErr" to warn the user against possible damage to the meter due to improper connections to the  $\mu\text{A}$ , mA, or A input jacks when other function (like voltage function) is selected.

## Set Beeper Off

Press the Hz button while turning the meter on to disable the push button operating beeper feature. However, the continuity and Jack Beep input warning features remain.  $\Omega$

## Auto Power Off (APO)

The Auto Power Off (APO) mode turns the meter off automatically to extend battery life after approximately 17 minutes of no activities. Activities are specified as: 1) Rotary switch or push button operations, and 2) Significant measuring readings of above 10% of range or non-OL  $\Omega$  readings. That is, the meter will intelligently avoid entering the APO mode when it is under normal measurements. To wake up the meter from APO, press the SELECT button momentarily or turn the rotary switch to the OFF position and then turn back on again. Always turn the rotary switch to the OFF position when the meter is not in use

## Disabling Auto Power Off

Press the RANGE button while turning the meter on to disable the Auto Power Off (APO) feature.

## SPECIFICATIONS

---

### General Specifications

<b>Display:</b>	3-4/5 digits 5000 counts lcd display
<b>Update rate:</b>	Digital data 5 per second nominal; 52 segments bar-graph 60 per second nominal
<b>AC SENSING:</b>	True RMS
<b>Operating temperature:</b>	0°C to 45°C (32°F to 113°F)
<b>Relative humidity:</b>	Maximum relative humidity 80% for temperature up to 31°C decreasing linearly to 50% relative humidity at 45°C (113°F)

<b>Pollution degree:</b>	2
<b>Storage temperature:</b>	-20°C to 60°C (-4°F to 140°F), < 80% R.H. (With battery removed)
<b>Altitude:</b>	Operating below 2000m
<b>Temperature coefficient:</b>	Nominal 0.15 x (specified accuracy)/ °C @ (0°C - 18°C/32°F - 64.4°F) or 28°C - 45°C/82.4°F - 113°F), or otherwise specified
<b>Sensing:</b>	AC, AC+DC true RMS
<b>Safety:</b>	Double insulation per iec61010-1 2nd ed., En61010-1 2nd ed., UI61010-1 2nd ed. & Can/csa c22.2 No. 61010.1-0.92 To category III 1000v AC & DC and category IV 600V AC & DC
<b>Overload protections:</b>	<b>µA &amp; mA:</b> 1A/600V, IR 10kA or better, F fuse <b>A:</b> 10A/600V, IR 100kA or better, F fuse <b>V:</b> 1050VRMS, 1450VPEAK <b>mV, Ω, &amp; others:</b> 600 VDC & VAC RMS

#### TERMINALS (TO COM) MEASUREMENT CATEGORY:

**V:** CATEGORY III 1000V AC & DC AND CATEGORY IV 600V AC & DC

**A / mAµA:** CATEGORY III AND CATEGORY IV 600 VAC AND 300 VDC.

**TRANSIENT PROTECTION:** 8KV (1.2/50µs SURGE)

**E.M.C.:** Meets en61326-1:2006 (EN55022, EN61000-3-2, EN61000-3-3, EN61000-4-2, EN61000-4-3, EN61000-4-4, , EN61000-4-5, EN61000-4-6, EN61000-4-8, EN61000-4-11)

**In an RF field of 3V/m:** Capacitance function is not specified

**Power supply:** Single standard 9V battery NEDA1604, JIS006P OR IEC6F22

**Power consumption:** 4.3mA typical

**Low battery:** Below approx. 7V

**Apo timing:** Idle for 17 minutes

**Apo consumption:** 50µA typical

<b>Dimension:</b>	186mm/7.3in (L) x 87mm/3.4in (W) x 35.5mm/1.4in (H); 198mm/7.8in (L) x 97mm/3.8in (W) x 55mm/2.2in (H) with holster
<b>Weight:</b>	340g/0.8lb; 430g/1.0lb with holster

## Electrical Specifications

Accuracy is  $\pm$ (% reading digits + number of digits) or otherwise specified, at 23°C  $\pm$  5°C & less than 75% relative humidity.

ACV & ACA accuracies are specified from 5 % to 100 % of range or otherwise specified. maximum crest factor <3:1 at full scale & <6:1 at half scale, and with frequency spectrums, besides fundamentals, fall within the meter specified AC bandwidth for non-sinusoidal waveforms.

## DC Voltage

RANGE	ACCURACY
50.00 MV	0.12% + 2D
500.0 MV	0.06% + 2D
5.000V, 50.00V, 500.0V, 1000V	0.08% + 2D

**NMRR:** >60DB @ 50/60HZ

**CMRR:** >120DB @ DC, 50/60HZ, RS=1K $\Omega$

**Input Impedance:** 10M $\Omega$ , 16pF nominal (44pF nominal for 50mV & 500mV ranges)

## AC Voltage

RANGE	ACCURACY
<b>50HZ -- 60HZ</b>	
50.00MV, 500.0MV, 5.000V, 50.00V, 500.0V, 1000V	0.5% + 3D
<b>40HZ -- 500HZ</b>	
50.00MV, 500.0MV	0.8% + 3D
5.000V, 50.00V, 500.0V	1.0% + 4D
1000V	1.2% + 4D

UP TO 20KHZ	
50.00MV, 500.0MV	0.5DB*
5.000V, 50.00V, 500.0V	3DB*
1000V	UNSPEC'D

\*SPECIFIED FROM 30% TO 100% OF RANGE

**CMRR:** >60DB @ DC TO 60HZ, RS=1KΩ

**Input Impedance:** 10MΩ, 16pF nominal (44pF nominal for 50mV & 500mV ranges)

### DC Current

RANGE	ACCURACY	BURDEN VOLTAGE
500.0μA	0.2%+4D	0.15MV/μA
5000μA		0.15MV/μA
50.00MA		3.3MV/MA
500.0MA		3.3MV/MA
5.000A		45MV/A
10.00A*		45MV/A

\*10a continuous, >10a to 15a (to 20a for cf-version) for 30 second max with 5 minutes cool down interval

### AC Current

RANGE	ACCURACY	BURDEN VOLTAGE
<b>50HZ -- 60HZ</b>		
500.0μA	0.6%+3D	0.15MV/μA
5000μA		0.15MV/μA
50.00MA		3.3MV/MA
500.0MA	1.0%+3D	3.3MV/MA

5.000A	0.6%+3D	45MV/A
10.00A*		45MV/A
<b>40HZ --1KHZ</b>		
500.0μA	0.8%+4D	0.15MV/μA
5000μA	0.8%+4D	0.15MV/μA
50.00MA	0.8%+4D	3.3MV/MA
500.0MA	1.0%+4D	3.3MV/MA
5.000A	0.8%+4D	45MV/A
10.00A*	0.8%+4D	45MV/A

\*10a continuous, >10a to 15a (to 20a for cf-version) for 30 second max with 5 minutes cool down interval

## Ohms

RANGE	ACCURACY
50.00Ω	0.3% + 6D
500.0Ω	0.1% + 3D
5.000KΩ, 50.00KΩ, 500.0KΩ	0.1% + 2D
5.000MΩ	0.4% + 3D
50.00MΩ	2.0% + 5D

**open circuit voltage** : < 1.3vdc  
(< 3vdc for 50Ω & 500Ω ranges)

### •))) Audible Continuity Tester

**Audible threshold:** between 20Ω and 200Ω response time < 100μS

### Crest Mode for V & A functions

**Accuracy:** specified accuracy  $\pm 150$  digits for changes > 0.8 ms in duration

## Frequency

FUNCTION	SENSITIVITY (SINE RMS)	RANGE
MV	300MV	10HZ - 125KHZ
5V	2V	10HZ - 125KHZ
50V	20V	10HZ - 20KHZ
500V	80V	10HZ - 1KHZ
1000V	300V	10HZ - 1KHZ
$\Omega$ , CX, DIODE	300MV	10HZ - 125KHZ
$\mu$ A, MA, A	10% F.S.	10HZ - 125KHZ

Accuracy: 0.01% + 2D

## Diode Tester

RANGE	ACCURACY	TEST CURRENT (TYPICAL)	OPEN CIRCUIT VOLTAGE
2.000V	1%+1D	0.4MA	< 3.5 VDC

## Capacitance

RANGE	ACCURACY*
50.00nF	0.8% + 3D
500.0nF	0.8% + 3D
5.000 $\mu$ F	1.5% + 3D
50.00 $\mu$ F	2.5% + 3D
500.0 $\mu$ F**	3.5% + 5D
9999 $\mu$ F**	5.0% + 5D

\*Accuracies with film capacitor or better

\*\*In manual-ranging mode, measurements not specified below 45.0 $\mu$ F and 450 $\mu$ F for 500.0 $\mu$ F and 9999 $\mu$ F ranges respectively



## Temperature

RANGE	ACCURACY*
-50 °C TO 1000 °C	0.3% + 3D
-58 °F TO 1832 °F	0.3% + 5D

\*Thermocouple range & accuracy not included

## MAINTENANCE AND REPAIR

---

### **WARNING**

*To avoid electrical shock, disconnect the meter from any circuit, remove the test leads from the input jacks and turn OFF the meter before opening the case. Do not operate with open case. Install only the same type of fuse or equivalent*

## Calibration

Periodic calibration at intervals of one year is recommended to maintain meter accuracy. Accuracy is specified for a period of one year after calibration.

If self-diagnostic message "rE-O" is being displayed while powering on, the meter is re-organizing internal parameters. Do not switch off the meter then, and it will be back to normal measurement shortly. However, if self-diagnostic message "C\_Er" is being displayed while powering on, some meter ranges might be largely out of specifications. To avoid mis-leading measurements, stop using the meter and send it for re-calibration. Refer to the LIMITED WARRANTY section for obtaining warranty or repairing service.

## Trouble Shooting

If the instrument fails to operate, check battery, fuses, leads, etc., and replace as necessary. Double check operating procedure as described in this user's manual. If the instrument voltage-resistance input terminal has subjected to high voltage transient (caused by lightning or switching surge to the system) by accident or abnormal conditions of operation, the series fusible resistors will be blown off (become high impedance) like fuses to protect the user and the instrument. Most measuring functions through this terminal will then be open circuit. The series fusible resistors and the spark gaps should then be replaced by qualified technician. Refer to the LIMITED WARRANTY section for obtaining warranty or repairing service.

## Cleaning and Storage

Periodically wipe the case with a damp cloth and mild detergent; do not use abrasives or solvents. If the meter is not to be used for periods of longer than 60 days, remove the battery and store it separately.

## Battery and Fuse Replacement

### Battery use:

9V alkaline battery NEDA1604A, JIS6AM6 or IEC6LF22

### Fuse:

**Fuse (F51) for  $\mu$ A current input:** 1A/600V, IR 10kA or better, F fuse;

**Fuse (F52) for A current input:** 10A/600V, IR 100kA or better, F fuse

### Battery replacement for models with battery access door:

Loosen the 2 screws from the battery access door of the case bottom. Lift the battery access door and thus the battery compartment up. Replace the battery. Re-fasten the screws.

### Fuse replacement:

Loosen the 4 screws from the case bottom. Lift the end of the case bottom nearest the input jacks until it unsnaps from the case top. Replace the blown fuse(s) and/or the battery. Replace the case bottom, and ensure that all the gaskets are properly seated and the two snaps on the case top (near the LCD side) are engaged. Re-fasten the screws.

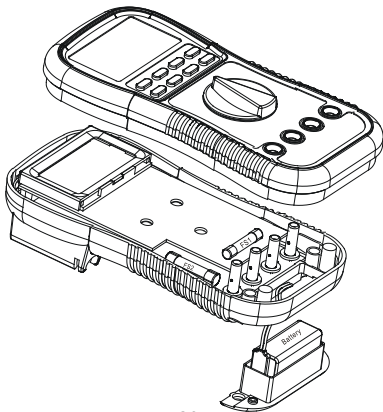



**Visit [www.Amprobe.com](http://www.Amprobe.com) for**

- Catalog
- Application notes
- Product specifications
- User manuals



Please Recycle